

Features

- Bask® heated surface creates spa-like relaxation with soothing warmth on your back, shoulders, and neck.
- Three heat settings allow you to customize the surface temperature.
- Single-speed whirlpool offers performance and value, with 5 fully adjustable jets.
- Hydromassage flow and direction can be controlled at each jet.
- Hourglass shape adds style and elegance to your bathroom.
- Integral flange helps prevent water from seeping behind wall and simplifies alcove installation.
- Textured bottom surface.

Material

- Acrylic.

Hydrotherapy

- Whirlpool.

Installation

- Left drain.
- Alcove.

Recommended Products/Accessories

- K-1278 Removable Apron
- K-7161-AF 1-1/2" adjustable pop-up drain above- or through-floor
- K-9695 5-Jet Trim Kit
- K-24916 Wireless Music Kit
- K-37380 30" Rough-in Cable Bath Drain
- K-37383 Rough-in cable bath drain, PVC, 30" cable with tubing
- K-37386 rough-in cable drain, PVC, 30" cable
- K-23726 Drain treatment
- K-23732 Tub & shower cleaner
- K-7265 Brass toe tap bath drain
- K-7259 Brass toe tap bath drain
- K-7166-AF Bath Drain



Codes/Standards

ASME A112.19.7/CSA B45.10
CSA B45.5/IAPMO Z124
ASTM E162
ASTM E662
UL 1795



**KOHLER® Plastic Baths and
Receptors Lifetime Limited
Warranty KOHLER® Hydrotherapy
Components Five-Year Limited
Warranty**

See website for detailed warranty information.

Available Colors/Finishes

Color tiles intended for reference only.

Color	Code	Description
-------	------	-------------

	0	White
	96	Biscuit
	NY	Dune

No change in measurements if connected with drain illustrated. (K-7161-AF)

 Recommended Faucet Location

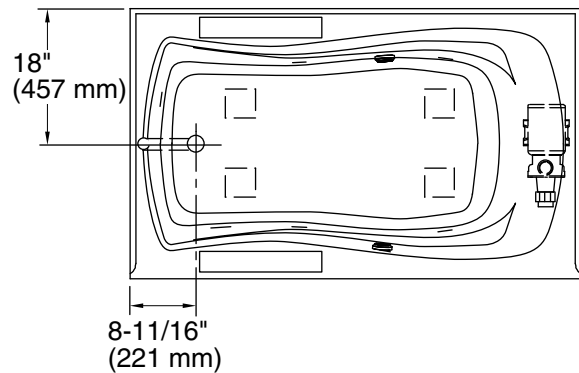

Pump/Control Access
(If Apron Is Not Used)
30" (762 mm) W x
15" (381 mm) H Min

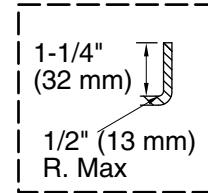

Integral Flange Detail

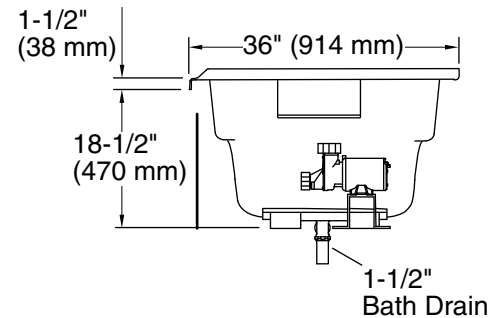
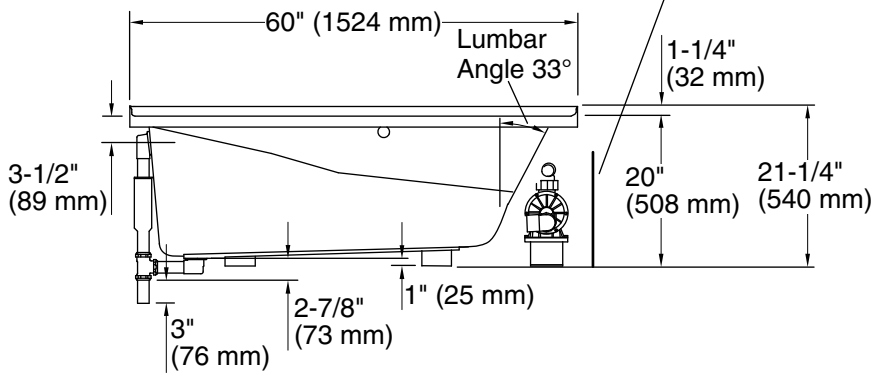

Required Electrical Service

One dedicated circuit required, protected with Class A Ground-Fault Circuit-Interrupter (GFCI). Outside North America, this device may be known as a Residual Current Device (RCD).

Pump, Heated 120 V, 15 A, 60 Hz
Surface:

Technical Information

All product dimensions are nominal.

Installation: Three-wall alcove
Drain location: Left
Basin area, bottom: 46" x 24" (1168 mm x 610 mm)
Basin area, top: 54" x 27" (1372 mm x 686 mm)
Weight: 111 lbs (50.3 kg)
Minimum floor load: 44 lbs/ft² (214.8 kg/m²)
Water depth: 14" (356 mm)
Water capacity: 63 gal (238.5 L)
Electrical component rating: Pump: 120 V, 7 A, 60 Hz
Heated Surface: 120 V, 0.5 A, 60 Hz, 65 W
Pump speed: Single

Notes

Measure your actual product for rough-in details.

Install this product according to the installation instructions.

The hot water supply should be 70% of the capacity of the bath or greater. Installations will vary.

If installing a rim-mount faucet, make sure there is no interference above or below the deck before drilling any holes.